

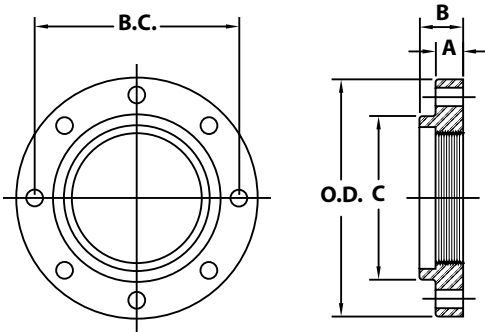

Flanges

ANSI/AWWA C115/A21.15



GENERAL SPECIFICATIONS

- MATERIAL:** Ductile Iron per ASTM A536
- PRESSURE:** 250 PSI
- DRILLING:** In accordance with ANSI/AWWA C110/21.10, ASME B16.1 Class 125 and ASME B16.42 Class 150
- DIMENSIONS:** Per ANSI/AWWA C115/A21.15
Flange O.D. & thickness per ANSI/AWWA C110/21.10
- FLANGE THREADS:** Taper pipe thread per ASME B1.20.1 adapted to ductile iron pipe O.D.

HI HUB THREADED 125 LB. FLANGES FOR DUCTILE PIPE (DUCTILE IRON)

NOM. SIZE	OD PIPE	FLANGE THK. A	FLANGE THK. B	THREAD LENGTH	OD FLANGE O.D.	HUB DIA. C	BOLT CIRCLE B.C.	BOLT HOLE DIA.	BOLT DIA. & LENGTH	NO. OF BOLT HOLES	WT (LBS.)
2	2.50	0.62	1.25	1.00	6.00	3.06	4.75	3/4	5/8 x 2 1/4	4	4
3	3.96	0.75	1.69	1.25	7.50	4.45	6.00	3/4	5/8 x 2 1/2	4	7
4	4.80	0.94	1.81	1.37	9.00	5.32	7.50	3/4	5/8 x 3	8	12
6	6.90	1.00	2.00	1.53	11.00	7.56	9.50	7/8	3/4 x 3 1/2	8	17
8	9.05	1.12	2.25	1.75	13.50	9.69	11.75	7/8	3/4 x 3 1/2	8	26
10	11.10	1.19	2.44	1.88	16.00	12.00	14.25	1	7/8 x 4	12	37
12	13.20	1.25	2.56	2.12	19.00	14.06	17.00	1	7/8 x 4	12	55
14	15.30	1.38	2.62	2.12	21.00	16.25	18.75	1 1/8	1 x 4 1/2	12	70
16	17.40	1.44	2.75	2.12	23.50	18.44	21.25	1 1/8	1 x 4 1/2	16	80
18	19.50	1.56	3.00	2.25	25.00	20.53	22.75	1 1/4	1 1/8 x 5	16	85
20	21.60	1.69	3.25	2.44	27.50	22.63	25.00	1 1/4	1 1/8 x 5	20	106
24	25.80	1.88	3.50	2.75	32.00	26.82	29.50	1 3/8	1 1/4 x 5 1/2	20	147
30	32.00	2.12	3.75	3.37	38.75	32.75	36.00	1 3/8	1 1/4 x 6 1/2	28	224
36	38.30	2.38	5.00	4.00	46.00	39.12	42.75	1 5/8	1 1/2 x 7	32	337
42	44.50	2.62	5.12	4.50	53.00	46.00	49.50	1 5/8	1 1/2 x 7 1/2	36	495
48	50.80	2.75	5.50	5.12	59.50	52.25	56.00	1 5/8	1 1/2 x 8	44	622
54	57.56	3.00	6.45	4.75	66.25	58.75	62.75	2	1 3/4 x 8 1/2	44	711
60	61.61	3.12	6.75	5.00	73.00	63.00	69.25	2	1 3/4 x 9	52	1084
64	65.67	3.38	7.06	5.25	80.00	67.18	76.00	2	1 3/4 x 9	52	1575

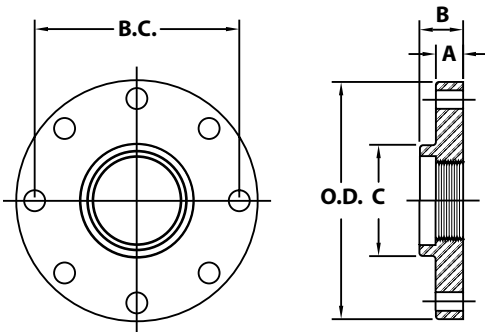

GENERAL SPECIFICATIONS

- MATERIAL:** Ductile Iron per ASTM A536
- PRESSURE:** 250 PSI
- DRILLING:** In accordance with ANSI/AWWA C110/21.10, ASME B16.1 Class 125 and ASME B16.42 Class 150
- DIMENSIONS:** Per ANSI/AWWA C115/A21.15
Flange O.D. & thickness per ANSI/AWWA C110/21.10
- FLANGE THREADS:** Taper pipe thread per ASME B1.20.1 adapted to ductile iron pipe O.D.

REDUCING 125 LB. FLANGES FOR DUCTILE PIPE (DUCTILE IRON)

NOM. SIZE	OD PIPE	FLANGE THK. A	FLANGE THK. B	THREAD LENGTH	OD FLANGE O.D.	HUB DIA. C	BOLT CIRCLE B.C.	BOLT HOLE DIA.	BOLT DIA. & LENGTH	NO. OF BOLT HOLES	WT (LBS.)
4 x 3	3.96	0.94	1.37	0.94	9.00	4.45	7.50	3/4	5/8 x 3	8	16
6 x 4	4.80	1.00	1.56	1.00	11.00	5.32	9.50	7/8	3/4 x 3 1/2	8	25
8 x 4	4.80	1.12	1.75	1.00	13.50	5.32	11.75	7/8	3/4 x 3 1/2	8	40
8 x 6	6.90	1.12	1.75	1.16	13.50	7.56	11.75	7/8	3/4 x 3 1/2	8	35
10 x 8	9.05	1.19	2.00	1.38	16.00	9.69	14.25	1	7/8 x 4	12	50
12 x 8	9.05	1.25	2.19	1.38	19.00	9.69	17.00	1	7/8 x 4	12	85
12 x 10	11.10	1.25	2.19	1.38	19.00	12.00	17.00	1	7/8 x 4	12	65



STAR[®] PIPE PRODUCTS



Flanges

ANSI/AWWA C115/A21.15

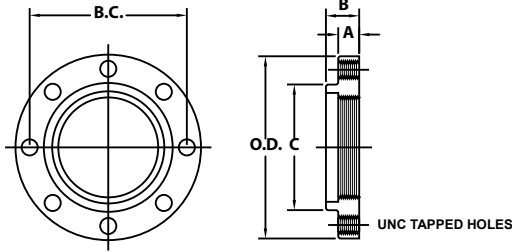

GENERAL SPECIFICATIONS

- MATERIAL:** Ductile Iron per ASTM A536
- PRESSURE:** 250 PSI
- DRILLING:** In accordance with ANSI/AWWA C110/21.10, ASME B16.1 Class 125 and ASME B16.42 Class 150
- DIMENSIONS:** Per ANSI/AWWA C115/A21.15
Flange O.D. & thickness per ANSI/AWWA C110/21.10
- BOLT HOLE THREADS:** UNC-2B Per ASME B1.1
- FLANGE THREADS:** Taper pipe thread per ASME B1.20.1 adapted to ductile iron pipe O.D.

THREADED 125 LB. FLANGES FOR STUDS FOR DUCTILE PIPE (DUCTILE IRON)

NOM. SIZE	OD PIPE	FLANGE THK. A	FLANGE THK. B	THREAD LENGTH	OD FLANGE O.D.	HUB DIA. C	BOLT CIRCLE B.C.	BOLT HOLE THREADS (UNC-2B)	NO. OF BOLT HOLES	WT (LBS.)
2	2.50	0.62	1.25	1.00	6.00	3.06	4.75	5/8 - 11	4	4
3	3.96	0.75	1.69	1.25	7.50	4.45	6.00	5/8 - 11	4	7
4	4.80	0.94	1.81	1.37	9.00	5.32	7.50	5/8 - 11	8	12
6	6.90	1.00	2.00	1.53	11.00	7.56	9.50	3/4 - 10	8	17
8	9.05	1.12	2.25	1.75	13.50	9.69	11.75	3/4 - 10	8	26
10	11.10	1.19	2.44	1.88	16.00	12.00	14.25	7/8 - 9	12	37
12	13.20	1.25	2.56	2.12	19.00	14.06	17.00	7/8 - 9	12	55
14	15.30	1.38	2.62	2.12	21.00	16.25	18.75	1 - 8	12	70
16	17.40	1.44	2.75	2.12	23.50	18.44	21.25	1 - 8	16	80
18	19.50	1.56	3.00	2.25	25.00	20.53	22.75	1 1/8 - 7	16	85
20	21.60	1.69	3.25	2.44	27.50	22.63	25.00	1 1/8 - 7	20	106
24	25.80	1.88	3.50	2.75	32.00	26.82	29.50	1 1/4 - 7	20	147
30	32.00	2.12	3.75	3.37	38.75	32.75	36.00	1 1/4 - 7	28	224
36	38.30	2.38	5.00	4.00	46.00	39.12	42.75	1 1/2 - 6	32	337
42	44.50	2.62	5.12	4.50	53.00	46.00	49.50	1 1/2 - 6	36	495
48	50.80	2.75	5.50	5.12	59.50	52.25	56.00	1 1/2 - 6	44	622
54	57.56	3.00	6.45	4.75	66.25	58.75	62.75	1 3/4 - 5	44	711
60	61.61	3.12	6.75	5.00	73.00	63.00	69.25	1 3/4 - 5	52	1084
64	65.67	3.38	7.06	5.25	80.00	67.18	76.00	1 3/4 - 5	52	1575

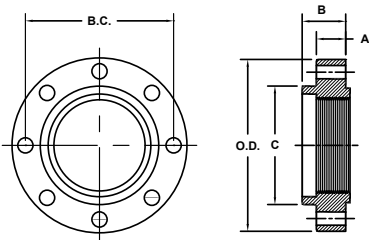

GENERAL SPECIFICATIONS

- MATERIAL:** Ductile Iron per ASTM A536
- PRESSURE:** 640 PSI
- DRILLING:** In accordance with ASME B16.1 Class 250 and ASME B16.42 Class 300
- DIMENSIONS:** Per ANSI/B16.1 Class 250 and ASME B16.42 Class 300.
- FLANGE THREADS:** Taper pipe thread per ASME B1.20.1 adapted to ductile iron pipe O.D.

THREADED 250 LB. FLANGES FOR DUCTILE PIPE (DUCTILE IRON)

NOM. SIZE	OD PIPE	FLANGE THK. A	FLANGE THK. B	THREAD LENGTH	OD FLANGE O.D.	HUB DIA. C	BOLT CIRCLE B.C.	BOLT HOLE DIA.	BOLT DIA. & LENGTH	NO. OF BOLT HOLES	WT (LBS.)
3	3.96	1.12	1.56	1.19	8.25	4.62	6.62	7/8	3/4 x 3 1/2	8	10
4	4.80	1.25	1.75	1.31	10.00	5.75	7.88	7/8	3/4 x 4	8	19
6	6.90	1.44	1.94	1.56	12.50	8.12	10.62	7/8	3/4 x 4	12	31
8	9.05	1.62	2.19	1.75	15.00	10.25	13.00	1	7/8 x 4 1/2	12	47
10	11.10	1.88	2.38	1.94	17.50	12.62	15.25	1 1/8	1 x 5 1/2	16	70
12	13.20	2.00	2.56	2.19	20.50	14.75	17.75	1 1/4	1 1/8 x 5 1/2	16	114
14	15.30	2.12	2.69	2.25	23.00	16.25	20.25	1 1/4	1 1/8 x 6	20	122
16	17.40	2.25	2.88	2.50	25.50	18.38	22.50	1 3/8	1 1/4 x 6 1/2	20	159
18	19.50	2.38	3.00	2.56	28.00	20.53	24.75	1 3/8	1 1/4 x 6 1/2	24	205
20	21.60	2.50	3.31	2.87	30.50	22.63	27.00	1 3/8	1 1/4 x 7	24	220
24	25.80	2.75	3.75	3.25	36.00	26.82	32.00	1 3/8	1 1/2 x 7 1/2	24	342
30	32.00	3.00	4.75	4.33	43.00	35.00	39.25	2	1 3/4 x 8 1/2	28	502
36	38.30	3.38	5.37	4.63	50.00	41.25	46.00	2 1/4	2 x 9 1/2	32	690
42	44.50	3.69	6.00	5.38	57.00	48.50	52.75	2 1/4	2 x 10	36	986
48	50.80	4.00	6.63	6.25	65.00	56.55	60.75	2 1/4	2 x 11	40	1499

UCAT22.01
* REGISTERED TRADEMARK OF STAR PIPE PRODUCTS

STAR[®] PIPE PRODUCTS



Flanges

ANSI/AWWA C115/A21.15

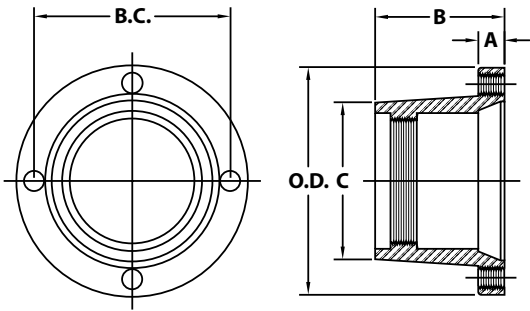

GENERAL SPECIFICATIONS

- MATERIAL:** Ductile Iron per ASTM A536
- PRESSURE:** 350 PSI 3"-24" and 250 PSI 30"-48"
- DRILLING:** In accordance with ANSI/AWWA C111/A21.11
- DIMENSIONS:** MJ BELL per ANSI/AWWA C111/A21.11
- BOLT HOLE THREADS:** UNC-2B Per ASME B1.1
- FLANGE THREADS:** Taper pipe thread per ASME B1.20.1 adapted to ductile iron pipe O.D.

MJ THREADED BELL FOR DUCTILE PIPE (DUCTILE IRON)										
NOM. SIZE	OD PIPE	FLANGE THK. A	TOTAL THK. B	THREAD LENGTH	OD FLANGE O.D.	HUB DIA. C	BOLT CIRCLE B.C.	BOLT HOLE THREADS (UNC-2B)	NO. OF BOLT HOLES	WT (LBS.)
3	3.96	0.94	4.12	0.94	7.69	4.50	6.19	5/8 - 11	4	11
4	4.80	1.00	4.25	1.00	9.12	5.32	7.50	3/4 - 10	4	15
6	6.90	1.06	4.43	1.16	11.12	7.56	9.50	3/4 - 10	6	22
8	9.05	1.12	4.75	1.38	13.37	9.73	11.75	3/4 - 10	6	35
10	11.10	1.19	4.87	1.50	15.69	12.06	14.00	3/4 - 10	8	46
12	13.20	1.25	5.12	1.75	17.94	14.16	16.25	3/4 - 10	8	55
14	15.30	1.31	6.50	1.87	20.31	16.25	18.75	3/4 - 10	10	94
16	17.40	1.38	6.75	2.06	22.56	18.44	21.00	3/4 - 10	12	118
18	19.50	1.44	7.00	2.25	24.83	20.53	23.25	3/4 - 10	12	125
20	21.60	1.50	7.25	2.44	27.08	22.63	25.50	3/4 - 10	14	150
24	25.80	1.62	7.50	2.75	31.58	26.82	30.00	3/4 - 10	16	235
30	32.00	1.81	9.13	3.37	39.12	32.75	36.88	1 - 8	20	375
36	38.30	2.00	9.75	4.00	46.00	39.12	43.75	1 - 8	24	500
42	44.50	2.00	10.50	4.00	53.12	46.00	50.62	1 1/4 - 7	28	735
48	50.80	2.00	11.00	4.12	60.00	52.25	57.50	1 1/4 - 7	32	940
54	57.56	2.00	11.50	4.25	65.70	59.18	63.20	1 1/4 - 7	36	978
60	61.61	2.00	11.50	5.00	70.22	63.00	67.72	1 1/4 - 7	36	1109

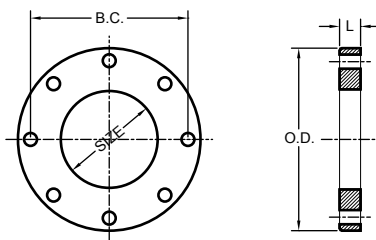

GENERAL SPECIFICATIONS

- MATERIAL:** Ductile Iron per ASTM A536
Gray Iron Per ASTM A48 Class 30B
- DRILLING:** In accordance with ANSI/AWWA C110/21.10, ASME B16.1 Class 125
And ASME B16.42 Class 150

FILLER FLANGES (DUCTILE IRON & CAST GRAY IRON)													
NOM. SIZE	OD FLANGE O.D.	BOLT CIRCLE B.C.	BOLT HOLE DIA.	NO. OF BOLT HOLES	L / WT. (LBS.)								
					1/2	3/4	1	1 1/2	2	3	4	5	6
3	7.50	6.00	3/4	4	5	7	9	14	18	27	36	45	54
4	9.00	7.50	3/4	8	6	9	12	19	25	37	49	62	74
6	11.00	9.50	7/8	8	8	12	16	24	32	48	64	81	97
8	13.50	11.75	7/8	8	11	17	23	34	46	69	92	114	137
10	16.00	14.25	1	12	15	22	29	44	59	88	118	147	176
12	19.00	17.00	1	12	21	31	42	63	84	126	167	209	251
14	21.00	18.75	1.12	12	23	35	47	70	94	141	188	235	282
16	23.50	21.25	1.12	16	28	42	56	85	113	169	225	282	338
18	25.00	22.75	1.25	16	28	42	56	85	113	169	225	282	338
20	27.50	25.00	1.25	20	33	50	66	100	133	199	265	332	398
24	32.00	29.50	1.38	20	42	63	84	126	167	251	335	419	502
30	38.75	36.00	1.38	28	56	84	112	168	224	336	448	560	672
36	46.00	42.75	1.63	32	75	113	150	225	300	450	601	751	901

STAR[®] PIPE PRODUCTS



Flanges

ANSI/AWWA C115/A21.15

GENERAL SPECIFICATIONS

MATERIAL: Ductile iron per ASTM A536

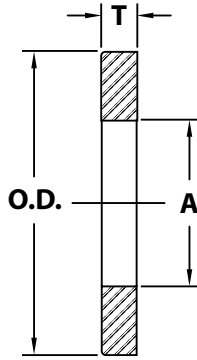
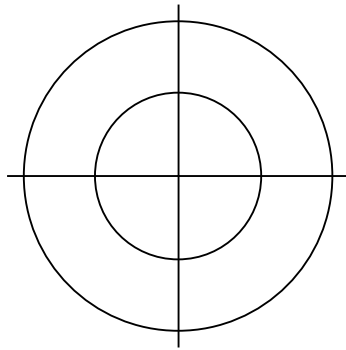

DUCTILE IRON ANCHOR FLANGES

NOM. SIZE	THICKNESS T	OD FLANGE O.D.	ID FLANGE A	WT (LBS.)
3	0.50	6.50	4.06	3
4	0.50	7.40	4.90	3
6	0.50	9.50	7.00	4
8	0.50	12.00	9.15	6
10	0.50	14.10	11.20	7
12	0.50	16.25	13.30	9
14	0.50	18.40	15.44	10
16	0.50	21.00	17.54	14
18	0.50	23.10	19.64	15
20	0.50	25.70	21.74	19
24	0.50	30.00	25.94	23
30	0.63	37.00	32.17	43
36	0.63	43.40	38.47	52
42	1.00	50.00	44.67	103
48	1.00	56.50	50.97	121
54	1.25	62.50	57.73	146
60	1.25	69.00	61.78	241
64	1.25	75.75	65.84	358

STAR® PIPE PRODUCTS

UCAT22.01
* REGISTERED TRADEMARK OF STAR PIPE PRODUCTS