



Compact Push-On Fittings

ANSI/AWWA C153/A21.53

4" - 24" DUCTILE IRON PUSH-ON JOINT COMPACT FITTINGS

GENERAL SPECIFICATIONS

- MATERIAL:** Ductile iron per ASTM A536
- PRESSURE:** 350 PSI rating for 4" - 24" sizes. Pressure rating applies to fittings only and does not apply to restraining lugs or external restrainers
- TESTING:** In accordance with ANSI/AWWA C153/A21.53 and UL requirements
- LAYING LENGTH:** In accordance with ANSI/AWWA C153/A21.53 (fittings not listed in ANSI/AWWA have dimensions per Star design as noted in the catalog)
- WEIGHTS:** Are in pounds, unless noted otherwise and do not include accessories, cement lining and coating
- FLANGES:** Flanged ends on fittings match ANSI/AWW C115/A21.15 and ANSI B16.1 class 125 flanges
- CEMENT LINING:** In accordance with ANSI/AWWA C104/A21.4 -- sizes 4" - 24" double thickness. [Click here for a pressure jetting discussion](http://www.starpipeproducts.com/pressure_jetting_discussion) or visit http://www.starpipeproducts.com/pressure_cleaning_guidelines.asp.
- COATING:** Asphaltic seal coat inside and out in accordance with ANSI/AWWA C104/A21.4 and referenced in ANSI/AWWA C153/A21.53
- GASKETS:** Dual hardness SBR in accordance with ANSI/AWWA C111/A21.11 (see pg. 37)
- APPROVALS:** 4" - 12" UL/ULC Listed | 4" and greater are UL/ANSI/NSF Standards 61 and 372 | 4" - 12" FM Approved. Please consult factory for detail listing and approvals.
- DIMENSIONS:** All dimensions are in inches unless noted otherwise. ([Click here for a short commentary on non-pressure sewer applications](http://www.starpipeproducts.com/non-pressure_sewer_applications.asp) or visit http://www.starpipeproducts.com/non-pressure_sewer_applications.asp. Review commentary before ordering or installing fittings for this application.
- INSTALLATION:** Per ANSI/AWWA C600 and C111 using DIP conforming to C150/C151 and PVC pipe conforming to C900/C905

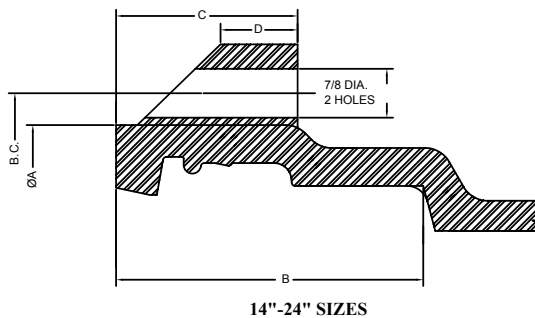
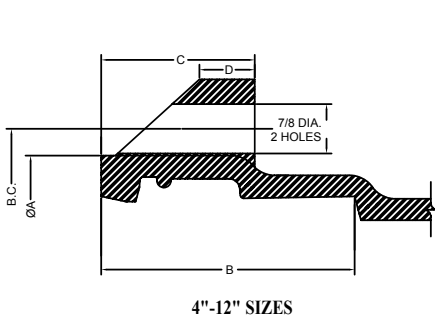

WATER QUALITY

PUSH-ON JOINT DIMENSIONS

NOM. SIZE	ØA	B.C.	B	C	D
4	6.38	7.50	4.02	2.17	1.12
6	8.52	9.56	4.02	2.17	1.12
8	10.80	11.82	4.49	2.72	1.12
10	12.91	14.00	4.49	2.91	1.12
12	15.05	16.25	5.00	2.99	1.12
14	17.89	18.75	5.50	3.12	1.25
16	20.05	21.00	5.50	3.25	1.25
18	22.35	23.25	5.50	3.25	1.25
20	24.47	25.50	5.50	3.25	1.25
24	28.79	30.00	6.00	3.25	1.25



Please note: All fittings are standard with two (2) restraining lugs. Bends 45° & 90° in sizes 4" - 12" are also available with four (4) restraining lugs.

STAR[®] PIPE PRODUCTS



Compact Push-On Fittings

ANSI/AWWA C153/A21.53

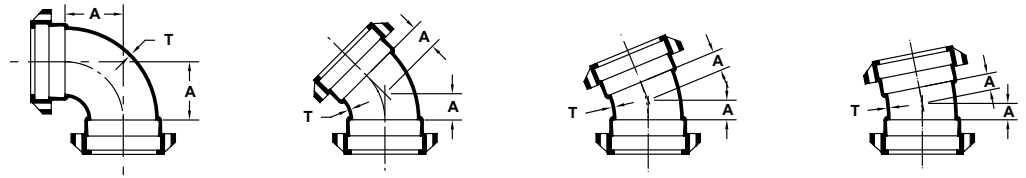

PO x PO BENDS		90° PO x PO BENDS (1/4)		45° PO x PO BENDS (1/8)		22 1/2° PO x PO BENDS (1/8)		11 1/4° PO x PO BENDS (1/32)	
NOM. SIZE	T	A	WT (LBS.)	A	WT (LBS.)	A	WT (LBS.)	A	WT (LBS.)
4	0.34	4.00	26	2.00	23	1.50	22	1.25	21
6	0.36	5.00	41	3.00	38	2.00	34	1.50	32
8	0.38	6.50	71	3.50	54	2.50	55	1.75	52
10	0.40	7.50	98	4.50	87	3.00	75	2.00	67
12	0.42	8.75	139	5.50	110	3.50	105	2.25	95
14	0.47	11.50	254	5.00	143	3.75	162	2.50	113
16	0.50	12.50	275	5.50	206	3.75	168	2.50	172
18	0.54	14.00	391	6.00	309	4.50	209	3.00	209
20	0.57	15.00	476	7.00	351	4.50	400	3.00	265
24	0.61	17.00	704	7.50	414	7.50	410	3.00	315

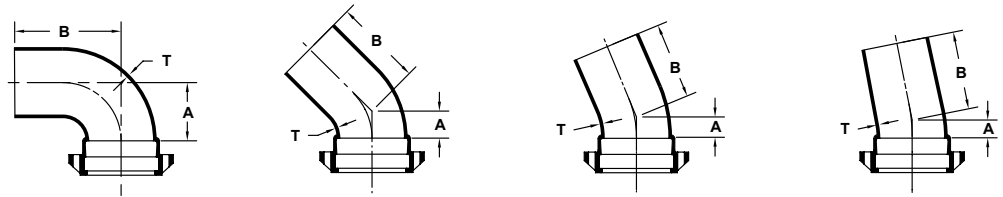

PO x PE BENDS		90° PO x PE BENDS (1/4)			45° PO x PE BENDS (1/8)			22 1/2° PO x PE BENDS (1/8)			11 1/4° PO x PE BENDS (1/32)		
NOM. SIZE	T	A	B	WT (LBS.)	A	B	WT (LBS.)	A	B	WT (LBS.)	A	B	WT (LBS.)
4	0.34	4.00	10.50	24	2.00	8.00	21	1.50	8.00	19	1.25	7.00	18
6	0.36	5.00	12.00	47	3.00	9.00	38	2.00	8.00	35	1.50	7.25	34
8	0.38	6.50	13.00	75	3.50	9.50	60	2.50	8.50	57	1.75	7.50	55

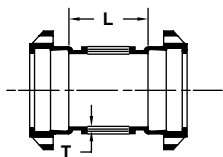

PO x TAPPED CROSS				
NOM. SIZE	T	L	MAX. TAP	WT (LBS.)
4	0.34	6.00	3	35
6	0.36	6.00	3	45
8	0.38	6.00	3	61
10	0.40	6.00	3	100
12	0.42	6.00	3	140

Threads in Accordance with ANSI/ASME B1.20.1

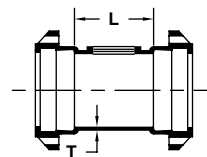

PO x TAPPED TEE				
NOM. SIZE	T	L	MAX. TAP	WT (LBS.)
4	0.34	6.00	3	35
6	0.36	6.00	3	45
8	0.38	6.00	3	61
10	0.40	6.00	3	100
12	0.42	6.00	3	140

Threads in Accordance with ANSI/ASME B1.20.1

STAR[®] PIPE PRODUCTS



Compact Push-On Fittings

ANSI/AWWA C153/A21.53

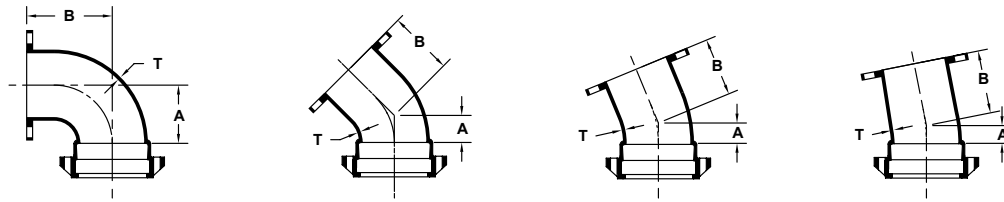

PO x FE BENDS		90° PO x FE BENDS (1/4)			45° PO x FE BENDS (1/8)			22 1/2° PO x FE BENDS (1/16)			11 1/4° PO x FE BENDS (1/32)		
NOM. SIZE	T	A	B	WT (LBS.)	A	B	WT (LBS.)	A	B	WT (LBS.)	A	B	WT (LBS.)
4	0.34	4.50	6.50	33	2.00	4.00	21	1.50	4.00	25	1.25	4.00	24
6	0.36	5.50	8.00	47	3.00	5.00	42	2.00	5.00	44	1.50	5.00	30
8	0.38	6.50	9.00	76	3.50	5.50	60	2.50	5.50	64	1.75	5.50	61
10	0.40	7.50	11.00	130	4.50	6.50	93	3.00	6.50	90	2.00	6.50	80
12	0.42	8.75	12.00	158	5.50	7.50	122	3.50	7.50	112	2.25	7.50	94
14	0.47	11.50	14.00	231	5.00	7.50	162	3.75	7.50	174	2.50	7.50	170
16	0.50	12.50	15.00	350	5.50	8.00	275	3.75	8.00	228	2.50	8.00	228
24	0.61	17.00	22.00	---	---	---	---	---	---	---	---	---	---

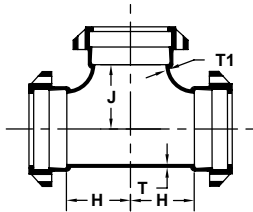

PO x PO TEES					
NOM. SIZE	T	T1	H	J	WT (LBS.)
4 x 4	0.34	0.34	4.00	4.00	40
6 x 4	0.36	0.34	4.00	5.00	50
6 x 6	0.36	0.36	5.00	5.00	59
8 x 4	0.38	0.34	4.00	6.50	75
8 x 6	0.38	0.36	5.00	6.50	88
8 x 8	0.38	0.38	6.50	6.50	99
10 x 4	0.40	0.34	4.00	7.50	95
10 x 6	0.40	0.36	5.00	7.50	103
10 x 8	0.40	0.38	6.50	7.50	122
10 x 10	0.40	0.40	7.50	7.50	134
12 x 4	0.42	0.34	4.00	8.75	122
12 x 6	0.42	0.36	5.00	8.75	126
12 x 8	0.42	0.38	6.50	8.75	148
12 x 10	0.42	0.40	7.50	8.75	161
12 x 12	0.42	0.42	8.75	8.75	192
14 x 6	0.47	0.36	6.50	10.50	176
14 x 10	0.47	0.40	8.50	10.50	195
14 x 12	0.47	0.42	9.50	10.50	196
14 x 14	0.47	0.47	10.50	10.50	209

PO x PO TEES (Con't)					
NOM. SIZE	T	T1	H	J	WT (LBS.)
16 x 6	0.50	0.36	6.50	11.50	221
16 x 8	0.50	0.38	7.50	11.50	257
16 x 10	0.50	0.40	8.50	11.50	232
16 x 12	0.50	0.42	9.50	11.50	288
16 x 14	0.50	0.47	10.50	11.50	349
16 x 16	0.50	0.50	12.50	12.50	460
18 x 6	0.54	0.36	6.50	12.50	320
18 x 8	0.54	0.38	7.50	12.50	325
18 x 10	0.54	0.40	8.50	12.50	344
18 x 12	0.54	0.42	9.50	12.50	385
18 x 14	0.54	0.47	10.50	12.50	352
18 x 16	0.54	0.50	11.50	12.50	362
18 x 18	0.54	0.54	14.00	14.00	550
20 x 6	0.57	0.36	6.50	14.00	355
20 x 10	0.57	0.40	9.00	14.00	369
20 x 12	0.57	0.42	10.00	14.00	457
20 x 14	0.57	0.47	11.00	14.00	484
20 x 16	0.57	0.50	12.00	14.00	610
20 x 18	0.57	0.54	13.00	14.00	639
20 x 20	0.57	0.57	15.00	15.00	644
24 x 6	0.61	0.36	7.00	16.00	450
24 x 8	0.61	0.38	8.00	16.00	492
24 x 10	0.61	0.40	9.00	16.00	520
24 x 12	0.61	0.42	10.00	16.00	541
24 x 14	0.61	0.47	11.00	16.00	715
24 x 16	0.61	0.50	12.00	16.00	755
24 x 18	0.61	0.54	13.00	16.00	708
24 x 20	0.61	0.57	14.00	16.00	845
24 x 24	0.61	0.61	17.00	17.00	884

(Con't)➔

STAR[®] PIPE PRODUCTS



Compact Push-On Fittings

ANSI/AWWA C153/A21.53

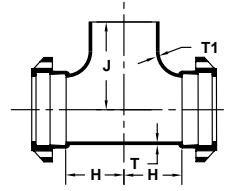
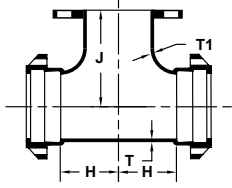

PO x FE TEES					
NOM. SIZE	T	T1	H	J	WT (LBS.)
4 x 4	0.34	0.34	4.50	6.50	47
6 x 4	0.36	0.34	4.50	8.00	60
6 x 6	0.36	0.36	5.50	8.00	69
8 x 4	0.38	0.34	4.50	9.00	81
8 x 6	0.38	0.36	5.50	9.00	87
8 x 8	0.38	0.38	6.50	9.00	115
10 x 4	0.40	0.34	4.50	11.00	97
10 x 6	0.40	0.36	5.50	11.00	114
10 x 8	0.40	0.38	6.50	11.00	133
10 x 10	0.40	0.40	7.50	11.00	165
12 x 4	0.42	0.34	4.50	12.00	125
12 x 6	0.42	0.36	5.50	12.00	131
12 x 8	0.42	0.38	6.50	12.00	166
12 x 10	0.42	0.40	7.50	12.00	142
12 x 12	0.42	0.42	8.75	12.00	210
16 x 6	0.50	0.36	6.50	15.00	236
16 x 8	0.50	0.38	7.50	15.00	269
16 x 10	0.50	0.40	8.50	15.00	310
16 x 12	0.50	0.42	9.50	15.00	348
16 x 14	0.50	0.47	10.50	15.00	342
16 x 16	0.50	0.50	11.50	15.00	355
18 x 6	0.54	0.36	6.50	15.50	301
18 x 8	0.54	0.38	7.50	15.50	319
18 x 10	0.54	0.40	8.50	15.50	337
18 x 14	0.54	0.47	10.50	15.50	393
18 x 16	0.54	0.50	11.50	15.50	420
20 x 6	0.57	0.36	6.50	17.00	341
20 x 10	0.57	0.40	9.00	17.00	420
20 x 14	0.57	0.47	11.00	17.00	474
20 x 16	0.57	0.50	12.00	18.00	498
20 x 18	0.57	0.54	13.00	18.00	528
24 x 6	0.61	0.36	7.00	19.00	420
24 x 10	0.61	0.40	9.00	19.00	468
24 x 12	0.61	0.42	10.00	19.00	503
24 x 14	0.61	0.47	11.00	19.00	531
24 x 16	0.61	0.50	12.00	19.00	555

PO x PE TEES					
NOM. SIZE	T	T1	H	J	WT (LBS.)
6 x 6	0.36	0.36	5.00	11.50	55
8 x 6	0.38	0.36	5.00	12.50	75
12 x 6	0.42	0.36	5.00	15.50	130

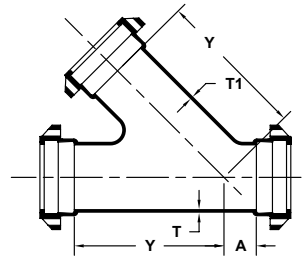

45° PO LATERALS					
NOM. SIZE	T	T1	A	Y	WT (LBS.)
4 x 4	0.34	0.34	2.50	9.50	55
6 x 4	0.36	0.34	3.00	13.00	76
6 x 6	0.36	0.36	3.00	13.00	85
8 x 4	0.38	0.34	3.50	16.00	89
8 x 6	0.38	0.36	3.50	16.00	125
8 x 8	0.38	0.38	3.50	16.00	140
10 x 4	0.40	0.34	3.50	19.00	144
10 x 6	0.40	0.36	3.50	19.00	154
10 x 8	0.40	0.38	3.50	19.00	160
10 x 10	0.40	0.40	3.50	19.00	170
12 x 4	0.42	0.34	4.50	22.50	224
12 x 6	0.42	0.36	4.50	22.50	236
12 x 8	0.42	0.38	4.50	22.50	259
12 x 10	0.42	0.40	4.50	22.50	282
12 x 12	0.42	0.42	4.50	22.50	300
14 x 6	0.47	0.36	0.00	19.50	236
14 x 8	0.47	0.38	1.50	21.00	255
14 x 10	0.47	0.40	3.00	22.50	325
14 x 14	0.47	0.47	6.00	25.00	475
16 x 6	0.50	0.36	0.00	21.00	281
16 x 8	0.50	0.38	1.00	22.50	305
16 x 12	0.50	0.42	3.50	25.00	346
16 x 16	0.50	0.50	6.00	28.00	380
18 x 18	0.75	0.75	7.00	29.00	812

STAR® PIPE PRODUCTS

UCAT19.01
* REGISTERED TRADEMARK OF STAR PIPE PRODUCTS



Compact Push-On Fittings

ANSI/AWWA C153/A21.53

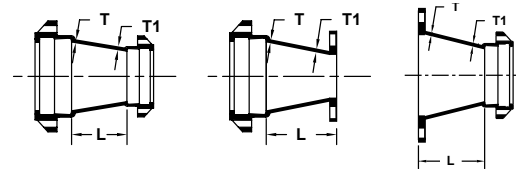
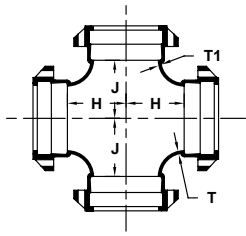

PO CROSSES					
NOM. SIZE	T	T1	H	J	WT (LBS.)
4 x 4	0.34	0.34	4.00	4.00	55
6 x 6	0.36	0.36	5.00	5.00	74
8 x 6	0.38	0.36	5.00	6.50	103
8 x 8	0.38	0.38	6.50	6.50	115
10 x 4	0.40	0.34	4.00	7.50	116
10 x 8	0.40	0.38	6.50	7.50	150
10 x 10	0.40	0.40	7.50	7.50	160
12 x 8	0.42	0.38	6.50	8.75	171
12 x 10	0.42	0.40	7.50	8.75	176
12 x 12	0.42	0.42	8.75	8.75	216
14 x 6	0.47	0.36	6.50	10.50	189
14 x 8	0.47	0.38	7.50	10.50	204
14 x 10	0.47	0.40	8.50	10.50	222
14 x 12	0.47	0.42	9.50	10.50	239
14 x 14	0.47	0.47	10.50	10.50	270
16 x 6	0.50	0.36	6.50	11.50	234
16 x 8	0.50	0.38	7.50	11.50	245
16 x 10	0.50	0.40	8.50	11.50	268
16 x 12	0.50	0.42	9.50	11.50	274
16 x 14	0.50	0.47	10.50	11.50	322
16 x 16	0.50	0.50	12.50	12.50	417
18 x 8	0.54	0.38	7.50	12.50	363
24 x 24	0.61	0.61	17.00	17.00	1056

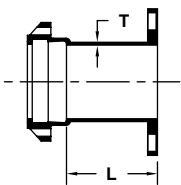

PO x FLANGE ADAPTER			
NOM. SIZE	T	L	WT (LBS.)
4	0.34	3.50	22
6	0.36	3.50	34
8	0.38	3.50	46
10	0.40	3.50	59
12	0.42	3.50	98
14	0.47	5.00	113
16	0.50	5.00	180
24	0.61	5.00	308

NOM. SIZE	T	T1	PO x PO		PO x FE		FE x PO	
			L	WT (LBS.)	L	WT (LBS.)	L	WT
6 x 4	0.36	0.34	4.00	30	6.00	32		
8 x 4	0.38	0.34	5.00	42	7.00	46		
8 x 6	0.38	0.36	4.00	43	6.00	47	6.00	45
10 x 4	0.40	0.34	7.00	53	9.00	55		
10 x 6	0.40	0.36	5.00	58	7.00	59		
10 x 8	0.40	0.38	4.00	62	6.00	61		
12 x 4	0.42	0.34	9.00	70	11.00	78		
12 x 6	0.42	0.36	7.00	77	9.00	73		
12 x 8	0.42	0.38	5.00	80	7.00	74		
12 x 10	0.42	0.40	4.00	82	6.00	95		
14 x 6	0.47	0.36	9.00	84	11.00	121		
14 x 8	0.47	0.38	7.00	85	9.00	128		
14 x 10	0.47	0.40	5.00	87	7.00	127		
14 x 12	0.47	0.42	4.00	104	6.00	144		
16 x 6	0.50	0.36	11.00	138	13.00	133		
16 x 8	0.50	0.38	9.00	137	11.00	141		
16 x 10	0.50	0.40	7.00	130	9.00	158		
16 x 12	0.50	0.42	5.00	135	7.00	172		
16 x 14	0.50	0.47	4.00	139	6.00	196		
18 x 8	0.54	0.38	13.00	140	16.00	157		
18 x 10	0.54	0.40	10.00	142	14.00	175		
18 x 12	0.54	0.42	7.00	167	12.00	215		
18 x 14	0.54	0.47	6.00	217	11.50	234		
18 x 16	0.54	0.50	5.00	202	10.50	246		
20 x 10	0.57	0.40	14.00	180	16.00	234		
20 x 12	0.57	0.42	12.00	205	---	---		
20 x 14	0.57	0.47	10.00	233	13.50	249		
20 x 16	0.57	0.50	7.00	250	11.50	272		
20 x 18	0.57	0.54	4.00	248	---	---		
24 x 12	0.61	0.42	16.00	308	18.00	262		
24 x 14	0.61	0.47	14.00	340	17.50	315		
24 x 16	0.61	0.50	12.00	324	15.50	328		
24 x 18	0.61	0.54	10.00	390	---	---		
24 x 20	0.61	0.57	7.00	421	---	---		

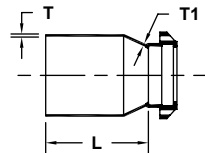

PO SMALL END BELL (SEB) REDUCER				
NOM. SIZE	T	T1	L	WT (LBS.)
6 x 4	0.37	0.35	9.50	27
8 x 4	0.39	0.35	9.50	29
8 x 6	0.39	0.37	9.50	37
12 x 6	0.43	0.37	12.50	63
12 x 8	0.43	0.39	10.50	64

STAR® PIPE PRODUCTS





Compact Push-On Fittings

ANSI/AWWA C153/A21.53

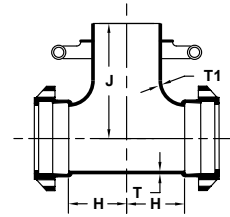
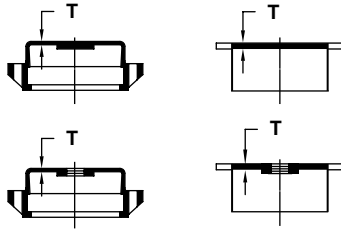

PO CAPS & PLUGS (SOLID OR TAPPED)				
NOM. SIZE	T	MAX. TAP	WT (LBS.)	
			CAPS	PLUGS
4	0.37	2	13	12
6	0.39	2	20	17
8	0.41	2	30	29
10	0.44	2	40	36
12	0.46	2	62	47
14	0.60	2.5	70	74
16	0.83	2.5	156	144
24	0.90	3	212	202

PO x SWIVEL HYDRANT TEES					
NOM. SIZE	T	T1	H	J	WT (LBS.)
6 x 6	0.36	0.36	6.00	9.50	71
8 x 6	0.38	0.36	6.00	10.50	87
10 x 6	0.40	0.36	7.00	12.50	100
12 x 6	0.42	0.36	7.00	13.50	138
16 x 6	0.50	0.36	6.50	15.00	229
20 x 6	0.57	0.36	7.00	17.50	400
24 x 6	0.61	0.36	7.00	19.50	525

Threads in Accordance with ANSI/ASME B1.20.1

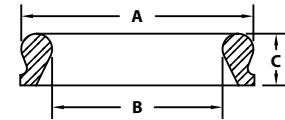
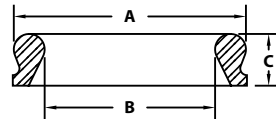

PO GASKETS			
NOM. SIZE	A	B	C
4	5.74	4.54	1.00
6	7.86	6.64	1.00
8	10.15	8.73	1.21
10	12.22	10.80	1.30
12	14.34	12.92	1.30
14	16.90	15.90	1.65
16	19.01	17.01	1.65
18	21.13	19.13	1.65
20	23.25	21.25	1.65
24	27.48	25.48	1.65

PO TRANSITION GASKETS			
NOM. SIZE	A	B	C
4	5.74	4.18	1.00
6	7.86	6.31	1.10
8	10.15	8.32	1.29
10	12.22	10.30	1.36
12	14.34	12.70	1.45

STAR[®] PIPE PRODUCTS



Standard Push-On Joint Gaskets

(SBR, NBR, EPDM, Neoprene, FKM)

ANSI/AWWA C111/A21.11

GASKET GENERAL SPECIFICATIONS

Star Pipe Products Push-On Gasket dimensions conform to the requirements for Trim Tyton® style bells. Gasket markings include size, Manufacturer's mark, Country of origin and product identification. No markings are positioned on sealing surfaces per the ANSI/AWWA C111/A21.11 standard. Push-on Transition gaskets follow the requirements of ANSI/AWWA C111/A21.11 where applicable.

Standard gasket material is vulcanized styrene butadiene rubber (SBR). Special application elastomers (EPDM, Nitrile, Neoprene & FKM) are available and shall be identified on all documentation and corresponding gaskets.

Star Pipe gaskets are manufactured under quality control standards and procedures that are maintained by the gasket supplier. Appropriate documentation is maintained by the manufacturer and available for review upon request.

Star Pipe gasket suppliers maintain a quality assurance program and manual that is reviewed and updated on an ongoing basis to ensure product quality. Star Pipe gasket suppliers perform in house testing and submit to random testing by Underwriters Laboratories, Inc. Star Pipe gasket providers are recognized under the component program (UL 194/ UL 157) of Underwriters Laboratories, Inc.

Star Pipe provides that our Push-On gaskets for potable or wastewater projects will perform as designed, based on the published chemical and environmental resistance data for "generic" rubber compounds. Star Pipe should be consulted for specific recommendations or for unusual applications.

GASKET PROPERTIES			
PROPERTY	ASTM TEST METHOD	MAIN BODY	HEEL
Hardness, Shore "A"	D2240	55±5	83±5
Minimum Tensile	D412	2000 PSI	1200 PSI
Minimum Elongation	D412	300%	125%
Minimum Aging	D573	60%	---
Maximum Compression Set	D395, Method B	20%	---
Resistance to Surface Ozone Cracking	D1149	No Cracking	---

GASKET TYPE	MAXIMUM CONTINUOUS TEMP	STANDARD USAGE
SBR (Styrene Butadiene Rubber/ Buna-S)	150 F	Drinking Water, Salt Water, Sanitary Sewage, Reclaimed Water, Raw Water, Storm Water. Not Recommended for Hydrocarbon Service
EPDM (Ethylene Propylene)	212 F	Alcohols, Dilute Acids, Dilute alkalis, Ketones (MEK/Acetone), Strong Oxidizing Chemicals; Drinking Water, Salt Water, Sanitary Sewage, Reclaimed Water, Raw Water, Storm Water. Not Recommended for Hydrocarbon Service
Neoprene (Polychlorprene / CR)	200 F	Hydrocarbons, Unrefined Petroleum Products, Greasy Waste; Salt Water, Sanitary Sewage, Reclaimed Water, Raw Water, Storm Water.
Nitrile (NBR / Buna-N)	150 F	Refined Oils and Fluids, Fats, Greases and Waste; Drinking water, Sanitary Sewage, Reclaimed Water, Raw Water, Storm Water.
FKM (Flouorelastomer / Viton®)	212 F	Aromatic Hydrocarbons, Chlorinated Hydrocarbons, Vegetable Oils, most Chemicals; Drinking Water, Reclaimed Water, Raw Water, Storm Water.

Trim Tyton® is a registered trademark of United States Pipe and Foundry Company.

Viton® is a registered trademark of E.I. Du Pont De Nemours & Company.

STAR® PIPE PRODUCTS



