

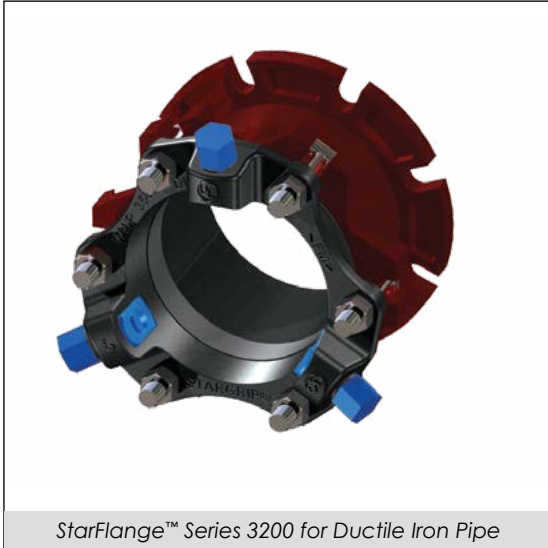

StarFlange™ series 3200

Restrained Adapter Flange Coupling
for Ductile Iron Pipe



StarFlange™ Series 3200 for Ductile Iron Pipe

INFORMATION

StarFlange™ Series 3200 is a restrained adapter flange coupling device designed to connect plain end ductile iron pipe to a flanged pipe, valve or fitting. A ductile iron flange body provides the flange connection and includes an O-ring gasket that seals with the mating flange. The Stargrip® Series 3000 provides restraint for the plain end ductile iron pipe. StarFlange™ Series 3200 pressure ratings listed on the next page are based on use with PC 350 or TC 50 (or above) ductile iron pipe.

Provides Flexibility to Accommodate Pipe Misalignment

FEATURES & ADVANTAGES

- Provides flexibility to accommodate pipe misalignment
- No special tools required for installation
- Fully restrained to pressure rating of pipe with a 2:1 safety factor
- Pipe end does not need to be square cut.
- StarFlange™ body and Stargrip® are manufactured from high strength Ductile Iron per ASTM A536, Grade 65-45-12.
- Flange meets ANSI Class 125/150 and ANSI/AWWA C115/A21.15 drill pattern.
- MJ gasket and O-ring flange gasket are made from styrene butadiene rubber (SBR) per ANSI/AWWA C111/A-21.11.
- T-bolts / nuts are produced from high strength low alloy steel per ANSI/AWWA C111/A-21.11
- Restraint wedges are heat-treated to minimum 370 BHN.
- Includes Stargrip®, Flange Adapter, MJ Gasket, O-Ring gasket and low alloy steel T-bolts
- StarFlange™ size 3"-12" are listed with Underwriters Laboratories Inc. and approved by Factory Mutual Research (FM).
- Standard gland color is black and StarFlange™ color is coral red.
- May also be used on steel pipe* up to 12" (***transition gasket required on 12" and under**). For 14" and larger steel applications, contact Star Pipe.

SAMPLE SPECIFICATIONS

Restrained adapter flange is to be used to connect plain end ductile iron pipe to a flanged pipe, valve or fitting. The device shall be manufactured of high strength ductile iron in accordance to ASTM A536 Grade 65-45-12 for all sizes. The restrainer portion of the device shall be of wedge type design with torque limiting bolts to insure proper engagement of the wedges.

Applicable dimensions shall conform to ANSI/AWWA C111/A21.15, C110/A21.10 and C153/A21.53. Flange ends to meet ANSI Class 125/150 & ANSI/AWWA C115/A21.15 drill pattern.

The restrained adapter flange shall have a maximum working pressure of 350 PSI for sizes 3"-16" and 250 PSI for sizes 18"-36". All sizes shall have a minimum safety factor of 2:1 (i.e. twice the maximum rating of the StarFlange™ Series 3200). Restrained flange adapter shall be Star® Pipe Products StarFlange™ Series 3200 or an approved equal.

JRCAT18.02



® REGISTERED TRADEMARK OF STAR PIPE PRODUCTS

STAR® PIPE PRODUCTS
HOUSTON CORPORATE | TOLL FREE 1-800-999-3009 | FAX 281-558-9000
www.starpipeproducts.com

STAR® PIPE PRODUCTS



StarFlange™ series 3200

Restrained Adapter Flange Coupling
for Ductile Iron Pipe

TECHNICAL INFORMATION

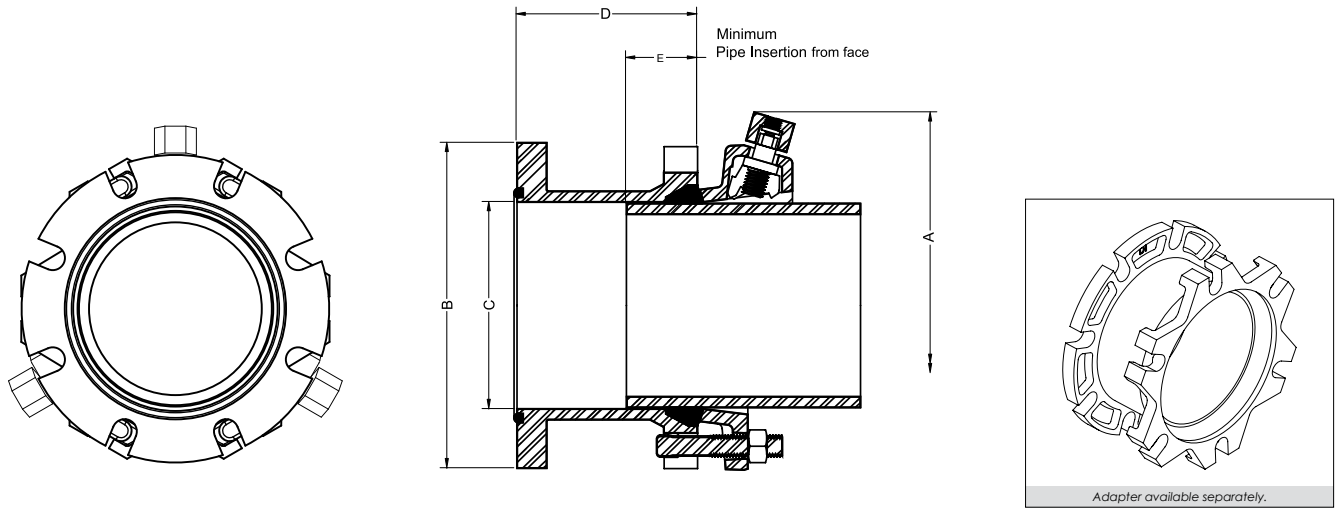

STARFLANGE™ 3200 SPECIFICATIONS*

NOM. SIZE	MAX PRESSURE RATING** (PSI)	A	A W/NUTS TWISTED OFF	B	C	D	E	1 MAX. JOINT DEFLECTION°	APPROX WT. (LBS)
3	350	9.85	8.45	7.50	4.06	3.88	2.13	5°	17
4	350	11.06	9.28	9.00	4.90	4.35	2.13	5°	23
6	350	13.06	11.38	11.00	7.00	5.25	2.50	5°	35
8	350	15.25	13.53	13.50	9.15	5.25	2.50	5°	47
10	350	17.25	15.58	16.00	11.20	5.62	2.50	3°	64
12	350	19.50	12.68	19.00	13.30	5.69	2.50	3°	87
14	350	21.25	19.82	21.00	15.44	6.67	3.00	2°	128
16	350	23.34	21.92	23.50	17.54	6.79	3.00	2°	152
18	250	26.40	24.84	25.00	19.64	7.40	3.00	1.5°	182
20	250	28.56	27.00	27.50	21.74	7.41	3.00	1.5°	204
24	250	33.86	32.30	32.00	25.94	7.90	3.00	1°	300
30	250	40.12	38.56	38.75	32.17	8.50	3.00	1°	520
36	250	46.42	44.86	46.00	38.47	9.00	3.00	1°	688

* All dimensions in inches except where indicated.

** Pressure ratings shall not exceed the maximum pressure rating of the ductile iron pipe it is installed on.

1 - Deflection attained at minimum pipe insertion.

Notes:

- StarFlange™ Series 3200 restraints are designed for use on ductile iron pipe that meets all physical requirements of ANSI/AWWA C151/A21.51. The pipe must be fully annealed to assure primary carbides have been dissolved and pearlite has been converted to ferrite. Please contact Star Pipe Products for technical assistance.
- For applications with vertical offsets, please contact Star Pipe Products for technical assistance.

STAR® PIPE PRODUCTS



StarFlange™ series 3200

Restrained Adapter Flange Coupling
for Ductile Iron Pipe

INSTALLATION INSTRUCTIONS - SIZES 3" - 36"

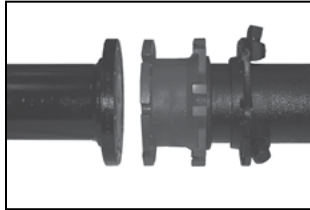

STEP 1

Check the StarFlange™ ensuring that no damage has occurred or parts are missing. Make sure that the O-ring gasket on the flange face of the StarFlange™ is securely in place.

The pipe end must be thoroughly cleaned for a distance of 2" greater than the length of the StarFlange™ body. (see dimension "D")

Slide the Stargrip® Gland on the plain end of the pipe making sure that the lip extension is towards the mechanical joint bell of the StarFlange™. Do not remove rubber washers prior to installation. Washers have been provided for proper wedge placement during shipment and installation.

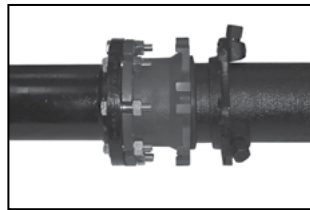

STEP 2

Brush both the gasket and the plain end of the pipe with soapy water or approved pipe lubricant, which meets ANSI/AWWA C111/A21.11. Slide the MJ gasket over the pipe with the beveled edge towards the MJ bell of StarFlange™.

Slide the StarFlange™ on to the pipe with the MJ bell towards the Stargrip® Gland. Pipe must be inserted into the StarFlange™ a minimum of 2.125" on 3"-4", 2.500" on 6"-12" and 3.000" on 14"-36" to attain maximum deflection per table.

Position the pipe and flanged end of StarFlange™ against the mating flange, making sure that the flange bolt holes line-up. Assemble the flanged joint using flange bolts. **Note: Flange bolts not supplied with StarFlange™.**

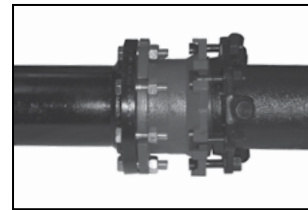

STEP 3

Center the pipe so that the space between the OD of the pipe and the ID of the StarFlange™ is even all around the pipe. Slide the MJ Gasket into the MJ bell recess of the StarFlange™.

Slide the Stargrip® towards the StarFlange™ with the Gland lip against the gasket. Insert T-bolts and hand-tighten nuts.

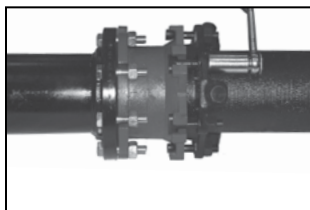

STEP 4

Tighten the T-bolts to normal range of bolt torque (see table below). It is necessary that the gland be brought up toward the bell flange evenly, maintaining approximately the same distance between the gland and the face of the flange at all points around the socket. T-bolts should be tightened alternately on opposite sides (Star Pattern) (See Table A).

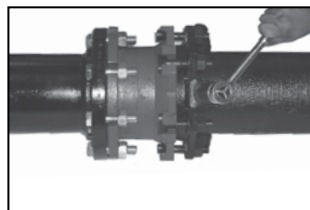

STEP 5

Hand tighten the torque limiting twist off bolts in a clockwise direction until all wedges are in firm contact with the pipe surface.

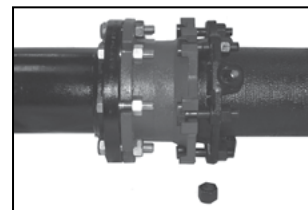

STEP 6

Continue tightening in an alternative manner going on the opposite sides [Star Pattern], until all of the bolt heads have been twisted off. Never turn a single bolt over 180 degrees without alternating to another bolt. If removal is necessary, utilize the 5/8" hex head provided. [If reassembly is required, assemble the joint in the same manner as above and tighten the wedge bolts to 90 ft-lbs on sizes 3"-20" and 120 ft-lbs on sizes 24"-36".

(TABLE A) T-HEAD BOLT & NUT DETAILS

PIPE SIZE (IN)	BOLT SIZE (IN)	RANGE ¹ OF TORQUE (FT-LBS)
3	5/8	45-60
4-24	3/4	75-90
30-36	1	100-120

¹These torque ranges are requirements of AWWA C600

Notes:

- StarFlange™ Series 3200 restraints are designed for use on ductile iron pipe that meets all physical requirements of ANSI/AWWA C151/A21.51. The pipe must be fully annealed to assure primary carbides have been dissolved and pearlite has been converted to ferrite. Please contact Star Pipe Products for technical assistance. Not to be used on plain end fittings or PVC or HDPE pipe.
- If effective sealing is not attained at the maximum torque indicated, then the joint should be disassembled, thoroughly cleaned, and reassembled. **Overstressing the bolts to compensate for poor installation practice is not acceptable.**
- May also be used on steel pipe* up to 12" (*transition gasket required on 12" and under). For 14" and larger steel applications, contact Star Pipe.
- Stargrips® must be adequately wrapped or protected if they are covered by concrete to ensure that concrete does not enter the wedge pocket.
- For applications exceeding the maximum pressure ratings listed, please contact Star Pipe Products for recommendations.
- For applications with vertical offsets please contact Star Pipe Products for technical assistance.
- For applications on existing pipe, the surface of the pipe needs to be sufficient for proper wedge engagement. Please contact Star Pipe Products for technical assistance.
- Pressure ratings shall not exceed the maximum pressure rating of the ductil iron pipe it is installed on.

JRCAT18.02



® REGISTERED TRADEMARK OF STAR PIPE PRODUCTS

STAR® PIPE PRODUCTS
HOUSTON CORPORATE | TOLL FREE 1-800-999-3009 | FAX 281-558-9000
www.starpipeproducts.com

STAR® PIPE PRODUCTS

