



Pipe Restrainers series 1000G2

1000G2C Restrainers for AWWA CI OD C900/C909 PVC/PVCO Pipe with MJ or Ductile Iron Push-On Fittings (Formerly Series 9000)



Series 1000G2C for C900 PVC Pipe/C909 PVCO Pipe

INFORMATION

Second Generation (Gen 2) PVC Restrainers for restraining mechanical joint or ductile iron push-on fittings with PVC pipe. These restraints work in any type of soil for a guaranteed joint restraint with rated pressure as listed below.

PVC restrainers can be installed on new or existing systems, totally eliminating the use of thrust blocks. These restrainers have internal serrations that lock onto the pipe and give 360° contact and support the pipe wall.

Rated to the New, Higher Pressure Classes in Latest Editions of AWWA C900 and C909

FEATURES & ADVANTAGES

- 360° contact, no pipe distortion or point loading and supports the wall of the pipe
- Made of Ductile Iron - ASTM Grade A536, Grade 65-45-12
- Restrainers work with Mechanical Joint or Ductile Iron Push-On Fittings.
- For use on 4" - 12" C900 PVC and C909 PVCO Pipe.
- The safety factor is twice (2:1) the maximum pressure rating listed on next page.
- Can be installed outside the trench, to ease installation
- Maintains full deflection on Mechanical Joint and Ductile Iron Push-On Fittings
- T-Bolts/Hex Nuts: low alloy steel per ANSI/AWWA C111/A21.11
- Clamping Bolts: SAE J429 Grade 5
- Series 1000G2 is approved by Factory Mutual Research in sizes 4" - 12" for use on C900 DR18 pipe for 150 PSI.
- Standard color is Graphite Black (RAL 9011).
- Originally introduced as the 9000, this improved design (Gen 2) provides increased performance and is rated to the new, higher pressure classes in latest editions of AWWA C900 and C909.



1000G2C with MJ Fitting

SAMPLE SPECIFICATIONS

PVC restraint devices shall be manufactured of high strength ductile iron in accordance to ASTM A536 Grade 65-45-12 for all sizes. Internal serrations will be provided with exact tolerances for a 360° contact and support of the pipe wall. PVC Restraint devices shall have a safety factor of 2:1 over the pipe pressure rating.



Pipe Restrainers series 1000G2

1000G2C Restrainers for AWWA CI OD C900/C909 PVC/PVCO Pipe with MJ or Ductile Iron Push-On Fittings (Formerly Series 9000)

TECHNICAL INFORMATION

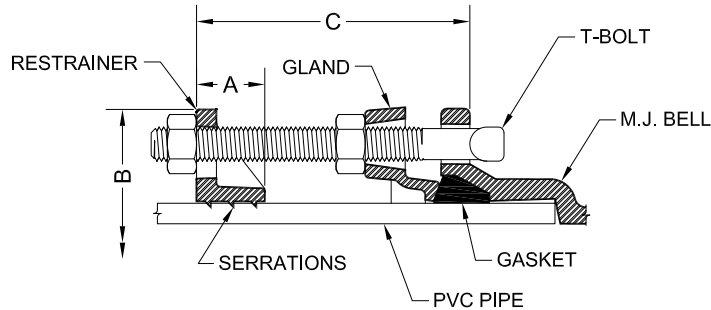

4" - 12" Sizes with MJ Fittings

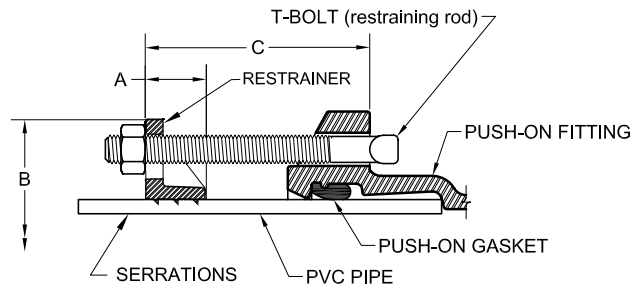

4" - 12" Sizes with Push-On Fittings

PIPE RESTRAINERS 1000G2C SPECIFICATIONS*

NOM. SIZE	PVC/PVCO PIPE WITH DUCTILE IRON PIPE O.D. STYLE 1000G2C O.D.	A	B APPROX.	C MAX.	RESTRAINT BOLTS (T-BOLTS)		CLAMPING BOLTS		APPROX WT. (LBS)
					QTY	SIZE	QTY	SIZE	
4	4.80	1.44	9.32	6.00	2	3/4 x 7	2	5/8 x 3 1/2	7.24
6	6.90	1.50	11.26	6.00	2	3/4 x 7	2	5/8 x 3 1/2	8.10
8	9.05	2.00	14.76	8.00	2	3/4 x 9	2	3/4 x 4	14.92
10	11.10	2.38	17.26	8.00	4	3/4 x 9	2	7/8 x 5	26.49
12	13.20	2.38	20.00	8.00	4	3/4 x 9	2	7/8 x 5	30.67

* All dimensions in inches except where indicated.

Table A - Maximum Working Pressure Rating with Occasional or Recurring Surges in PSI for Plastic Pipes Made to CI OD Diameter Regimen

NOM. SIZE (IN)	C900			C909
	DR14	DR18	DR25	PC 235
4	305	235	165	235
6	305	235	165	235
8	305	235	165	235
10	305	235	165	235
12	305	235	165	235

STAR® PIPE PRODUCTS



Pipe Restrainers series 1000G2

1000G2C Restrainers for AWWA CI OD C900/C909 PVC/PVCO and Ductile Iron Pipe with MJ or Ductile Iron Push-On Fittings (Formerly Series 9000)

INSTALLATION INSTRUCTIONS (SERIES 1000G2 4"-12")

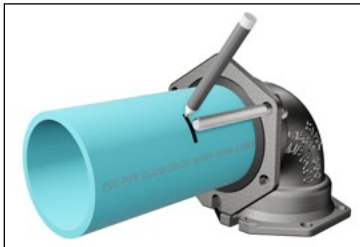

STEP 1

To ensure the rubber gasket will seal effectively, clean and remove all loose materials from the mating surfaces. If the pipe being installed is PVC/PVCO, verify that the end going into the MJ bell is square cut. If not, remove all but 1/8" of the bevel and debur it. Insert and completely home the pipe into the MJ fitting bell. Then insert one of the long T-bolts provided through one of the holes as shown. Mark a line 1 1/4" away from the end of the T-bolt and towards the MJ bell as shown.

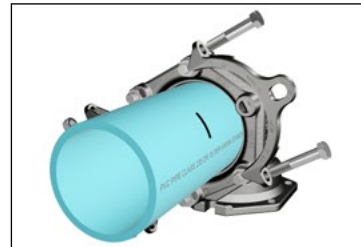

STEP 2

Assemble the MJ joint using the gland, gasket and T-bolts per the AWWA standards and as modified for AWWA C909 pipe in these guidelines. (Note that the long T-bolts are installed later.) Next, assemble the restrainer on the pipe so that it is even with the line marked on the pipe in Step No. 1. Make sure that the open ends of the restrainer ears are toward the MJ fitting bell. Also ensure that the holes in the restrainer ears line up with the bolt holes of the MJ gland. Evenly tighten the restrainer clamping bolts to the recommended torque shown below.

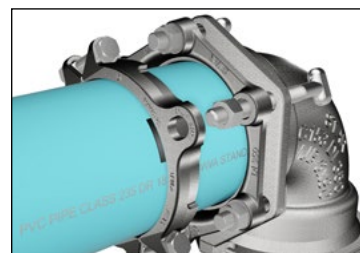

STEP 3

Insert one of the long T-bolts provided, installing one nut each between the gland and the restrainer as shown. Follow the same procedure for the remaining long T-bolts. Tighten nuts against the MJ gland per the AWWA standards and as modified for AWWA C909 pipe in these guidelines. (See table for T-bolt/nut torque details.)

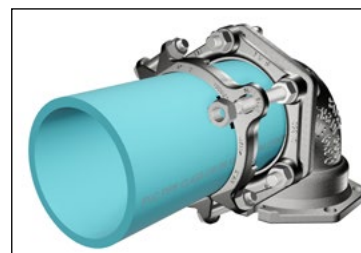

STEP 4

Snug tighten the second nut on each long T-Bolt against the restrainer as shown. Washers are provided for sizes 8" to 12".

Caution: Do not over-tighten the restraining nuts. Turn nut to hand tight plus half turn.

T-HEAD BOLT & NUT DETAILS			
PIPE SIZE (IN)	BOLT SIZE (IN)	RANGE OF TORQUE (FT-LBS)	
		C900/DI PIPE	C909
4-12	3/4	75 - 90	55 - 65

RECOMMENDED TORQUE (CLAMPING BOLTS)		
PIPE SIZE (IN)	C900/C909 (FT-LBS)	DI PIPE (FT-LBS)
4-10	100	110
12	130	130

STAR® PIPE PRODUCTS



Pipe Restrainers series 1100G2

1100G2C Bell Restrainers for AWWA CI OD C900/C909 PVC/PVCO Pipe Joints
(Formerly Series 9100)



Series 1100G2C for C900 PVC/C909 PVCO Pipe

INFORMATION

Second Generation (Gen 2) PVC Restrainers for restraining PVC pipe bell joints. These restraints work in any type of soil for a guaranteed joint restraint with rated pressure as listed below.

PVC restrainers can be installed on new or existing systems, totally eliminating the use of thrust blocks. These restrainers have internal serrations that lock onto the pipe and give 360° contact and support the pipe wall. Restraint devices may be used with any type of PVC piping system.

Rated to the New, Higher Pressure Classes in Latest Editions of AWWA C900 and C909*

FEATURES & ADVANTAGES

- 360° contact, no pipe distortion or point loading
- Made of Ductile Iron - ASTM Grade 536, Grade 65-45-12
- Restrainers work with Push-On Pipe Bells.
- For use on 4" - 12" C900 PVC and C909 PVCO pipe.
- The safety factor is twice (2:1) the maximum pressure rating listed on next page.
- Can be installed outside the trench, to ease installation
- Rods/Hex Nuts: low alloy steel per ANSI/AWWA C111/A21.11
- Clamping Bolts: SAE J429 Grade 5
- Series 1100G2 is approved by Factory Mutual Research in sizes 4"- 12" for use on C900 PVC DR18 for 150 PSI.
- Standard color is Graphite Black (RAL 9011).
- Originally introduced as the 9100, this improved design (Gen 2) provides increased performance and is rated to the new, higher pressure classes in latest editions of AWWA C900 and C909*.



Series 1100G2C

* See table on next page.

SAMPLE SPECIFICATIONS

PVC restraint devices shall be manufactured of high strength ductile iron in accordance to ASTM A536 Grade 65-45-12 for all sizes. Internal serrations will be provided with exact tolerances for a 360° contact and support of the pipe wall. PVC Restraint devices shall have a safety factor of 2:1 over the pressure rating.

JRCAT17.01



® REGISTERED TRADEMARK OF STAR PIPE PRODUCTS

STAR® PIPE PRODUCTS
HOUSTON CORPORATE | TOLL FREE 1-800-999-3009 | FAX 281-558-9000
www.starpipeproducts.com

STAR® PIPE PRODUCTS



Pipe Restrainers series 1100G2

1100G2C Bell Restrainers for AWWA CI OD C900/C909 PVC/PVCO Joints
(Formerly Series 9100)

TECHNICAL INFORMATION

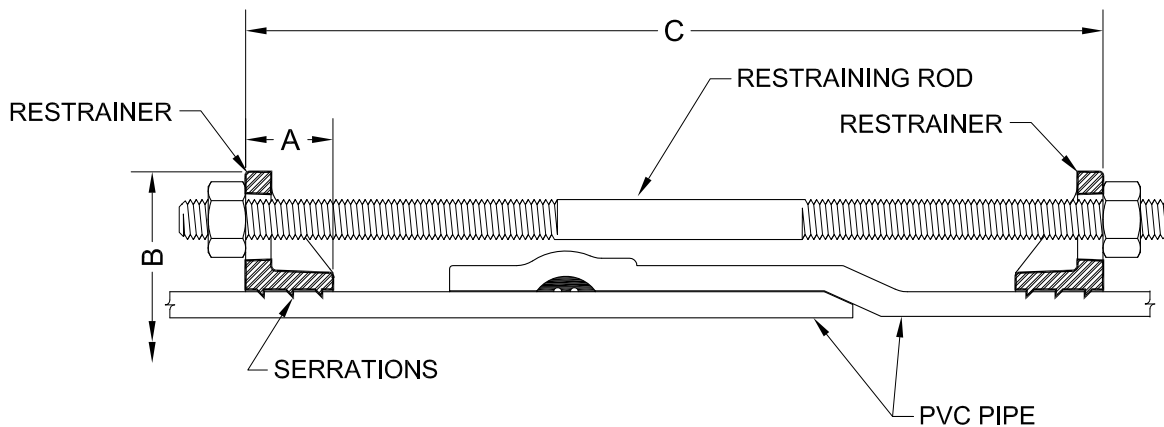

4" - 12" Sizes

PIPE RESTRAINERS 1100G2C SPECIFICATIONS*

NOM. SIZE	PVC/PVCO PIPE WITH DUCTILE IRON PIPE O.D. STYLE 1100G2C	A	B APPROX.	C MAX.	RESTRAINT RODS		CLAMPING BOLTS		APPROX WT. (LBS)
	O.D.				QTY	SIZE	QTY	SIZE	
4	4.80	1.44	9.32	15.00	2	3/4 x 17	4	5/8 x 3 1/2	12.63
6	6.90	1.50	11.26	15.00	2	3/4 x 17	4	5/8 x 3 1/2	14.35
8	9.05	2.00	14.76	22.00	2	3/4 x 24	4	3/4 x 4	27.45
10	11.10	2.38	17.26	22.00	4	3/4 x 24	4	7/8 x 5	48.21
12	13.20	2.38	20.00	22.00	4	3/4 x 24	4	7/8 x 5	56.57

* All dimensions in inches except where indicated.

MAXIMUM WORKING PRESSURE RATING WITH OCCASIONAL & RECURRING SURGES

NOM. SIZE (IN)	C900			C909
	DR14	DR18	DR25	PC 235
4	305	235	165	235
6	305	235	165	235
8	305	235	165	235
10	305	235	165	235
12	305	235	165	235

STAR® PIPE PRODUCTS



Pipe Restrainers series 1100G2

1100G2C Bell Restrainers for AWWA CI OD C900/C909 PVC/PVCO and Ductile Iron Pipe Joints (Formerly Series 9100)

INSTALLATION INSTRUCTIONS (SERIES 1100G2 4"-12")

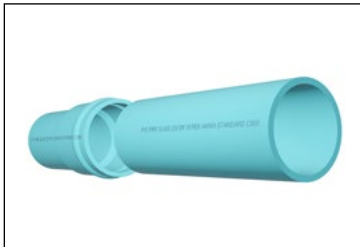

STEP 1

Assemble the spigot end of first pipe into the second pipe's bell per the pipe manufacturer's instructions.

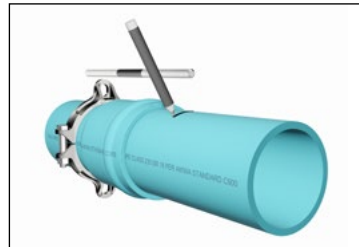

STEP 2

Assemble one restrainer behind the bell of pipe. Make sure that the open end of the restrainer ears are toward the joint. Evenly tighten the restrainer clamping bolts to the recommended torque, ensuring the gap between pads on both sides remain even. Use one of the restraint rods as a guide to position the restraint on spigot end. Mark a reference line such that the restraint rod ends extend past each nut approximately 1/2".

NOTE: The length of the PVC pipe bell varies from manufacturer to manufacturer. Please contact Star Pipe Products if rod length is too short.

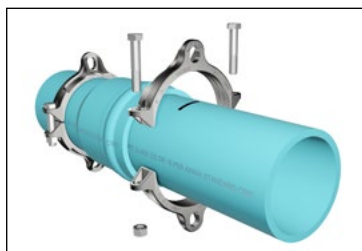

STEP 3

Assemble the second restrainer on the spigot end of pipe. Make sure that the open end of the restrainer ears are toward the joint. After aligning the second restrainer with the first one, tighten the clamping bolts to recommended torque evenly such that the gap between pads on both sides remain even.

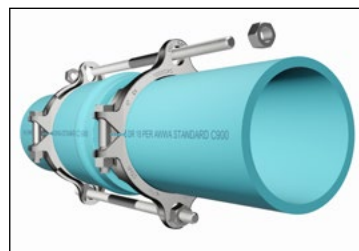

STEP 4

Insert the restraining rods through the restrainer ears. Snug tighten all nuts such that rods stick out approximately 0.50" past the nut on each end. Washers are provided for size 8"-12".

Caution: Do not over - tighten restraining nuts. Turn nut to hand tight plus half turn.

RECOMMENDED TORQUE (CLAMPING BOLTS)		
PIPE SIZE (IN)	C900/C909 (FT-LBS)	DI PIPE (FT-LBS)
4-10	100	110
12	130	130

STAR® PIPE PRODUCTS



Pipe Restrainers series 1000G2 & 1100G2

1000G2C & 1100G2C For Use On Ductile Iron Pipe

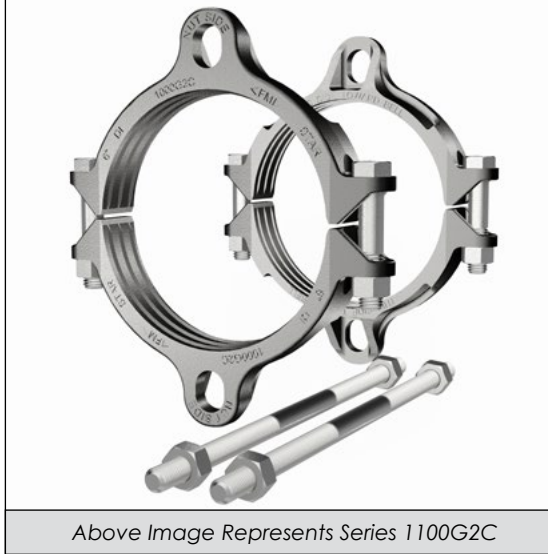

Above Image Represents Series 1100G2C

INFORMATION

Second Generation (Gen 2) Pipe restrainers for restraining ductile iron pipe with mechanical joint or push-on fittings and DIP bell joints.

Pipe restrainers can be installed on new or existing systems, totally eliminating the use of thrust blocks. These restrainers have internal serrations that lock onto the pipe and give 360° contact and support the pipe wall.

For Use on Ductile Iron Pipe

FEATURES & ADVANTAGES

- Castings made of Ductile Iron - ASTM A536, Grade 65-45-12
- Restrainers work with Mechanical Joint or Ductile Iron Push-On Fittings and with Ductile Iron Pipe manufactured per ANSI/AWWA C-151/A21.51.
- The safety factor is twice (2:1) the maximum pressure rating listed on next page.
- Maintains full deflection on Mechanical Joint and Push-On Fittings
- T-Bolts/Rods/Hex Nuts: Low alloy steel per ANSI/AWWA C111/A21.11
- Clamping Bolts: SAE J429 Grade 5

Notes:

- *Not recommended for installations on machined end pipe or fittings*
- *Installation requires clamp bolt torque values be applied as indicated on the next page.*
- *Installation and testing to be in accordance with the latest version of ANSI/AWWA C600*
- *For higher pressure requirements, please contact Star® Pipe Products*
- *Pipe hardness not to exceed 230 BHN.*

SAMPLE SPECIFICATIONS

Pipe restraining devices shall be manufactured of high strength ductile iron in accordance to ASTM A536 Grade 65-45-12 for all sizes. Internal serrations will be provided with exact tolerance for a 360° contact and support of the pipe wall. Pipe restraining devices shall have a safety factor of 2:1 over the pressure rating.

STAR® PIPE PRODUCTS



Pipe Restrainers series 1000G2 & 1100G2

1000G2C & 1100G2C For Use On Ductile Iron Pipe

TECHNICAL INFORMATION

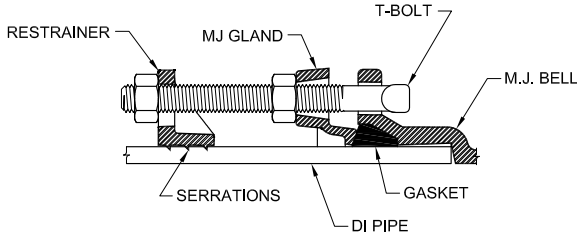

Series 1000G2
(4" - 12" Sizes with MJ Fittings)

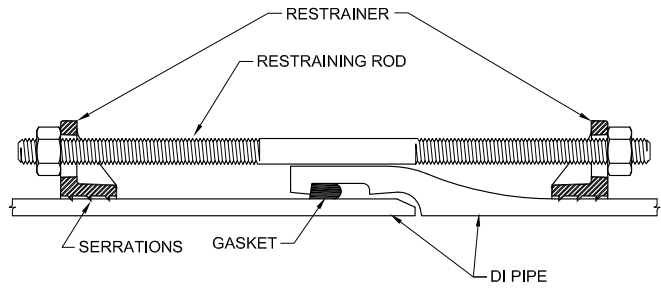

Series 1100G2
(4" - 12" Sizes with Pipe to Pipe Connection)

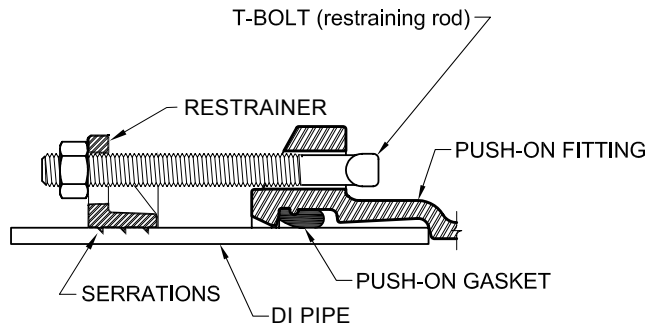

Series 1000G2
(4" - 12" Sizes with Push-On Fittings)

TABLE A - Pressure Rating For Ductile Iron Pipe-To-Pipe Connections and Ductile Iron Pipe to MJ Fitting Connections

NOMINAL SIZE	MAXIMUM PRESSURE RATINGS (PSI)	CLAMP BOLT TORQUE (FT-LBS)
4" - 10"	250	110 min.
12"	200	110 min.

TABLE B - Pressure Rating For DI Pipe To Ductile Iron Push-On Fitting Connections

NOMINAL SIZE	MAXIMUM PRESSURE RATINGS (PSI)	CLAMP BOLT TORQUE (FT-LBS)
4" - 8"	250	110 min.
10" - 12"	100	110 min.

STAR® PIPE PRODUCTS



Pipe Restrainers series 1200G2

1200G2C Restrainers for C900/C909 PVC/PVCO Pipe and PVC Pressure Fittings w/Ductile Iron Pipe OD (Formerly Series 9200)



1200G2C Restrainers for C900/C909 PVC Pipe with C907 Fitting Bell

INFORMATION

Second Generation (Gen 2) PVC Restrainers are for restraining bell joints between AWWA C900/C909 PVC/PVCO pipe and PVC pressure fittings. The PVC pressure fitting may be PC235 psi molded AWWA C907 PVC pressure fittings or PR 235 psi fabricated PVC pressure fittings.

PVC restrainers can be installed on new or existing systems, totally eliminating the use of thrust blocks. These restrainers have internal serrations that lock onto the pipe and give 360° contact and support the pipe wall.

Rated to the New, Higher Pressure Classes in Latest Editions of AWWA C900 and C909*

FEATURES & ADVANTAGES

- 360° contact, no pipe distortion or point loading and supports the wall of the pipe and fitting bell.
- Made of Ductile Iron - ASTM Grade 536, Grade 65-45-12
- Restrainers work with either
 - PC235 psi molded AWWA C907 PVC pressure fittings or
 - PR235 psi fabricated PVC pressure fittings.
- The safety factor is twice (2:1) the maximum pressure rating listed on next page.
- Can be installed outside the trench, to ease installation
- T-Bolts/Rods/Hex Nuts: low alloy steel per ANSI/AWWA C111/A21.11
- Clamping Bolts: SAE J429 Grade5
- Standard gland color is Graphite Black (RAL 9011).
- Originally introduced as the 9200, this improved design (Gen 2) provides increased performance and is rated to the new, higher pressure classes in latest editions of AWWA C900 and C909*.



1200G2 Restraint

* See table on next page.

SAMPLE SPECIFICATIONS

PVC restraint devices shall be manufactured of high strength ductile iron in accordance to ASTM A536 Grade 65-45-12 for all sizes. Internal serrations will be provided with exact tolerances for a 360° contact and support of the pipe wall. PVC Restraint devices shall have a safety factor of 2:1 over the pressure rating.

JRCAT17.01



® REGISTERED TRADEMARK OF STAR PIPE PRODUCTS

STAR® PIPE PRODUCTS
HOUSTON CORPORATE | TOLL FREE 1-800-999-3009 | FAX 281-558-9000
www.starpipeproducts.com

STAR® PIPE PRODUCTS



Pipe Restrainers series 1200G2

1200G2C Restrainers for C900/C909 PVC/PVCO Pipe and PVC Pressure Fittings w/Ductile Iron Pipe OD (Formerly Series 9200)

TECHNICAL INFORMATION

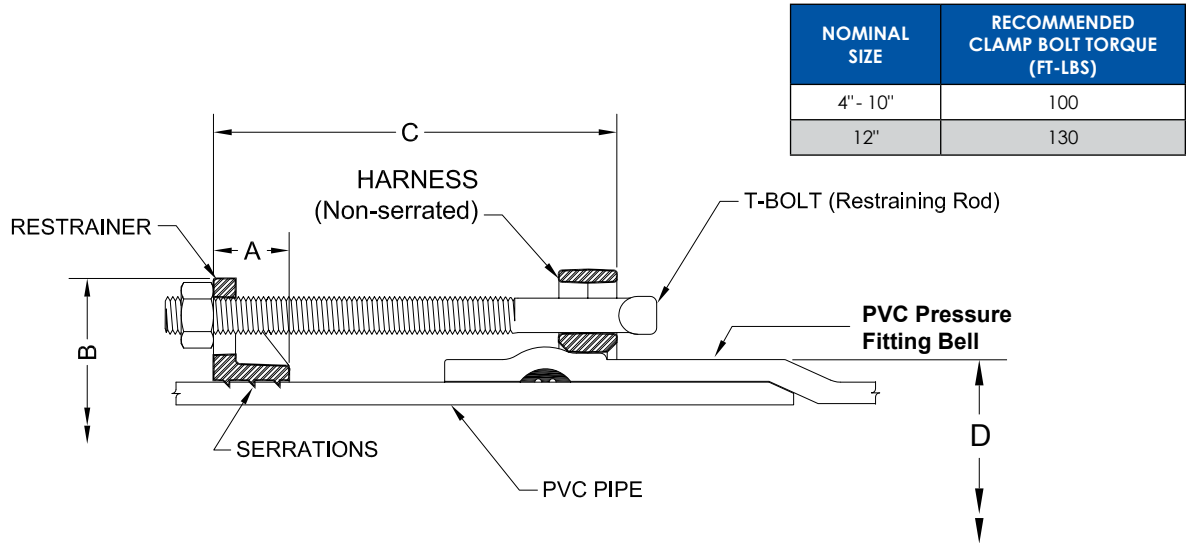

NOMINAL SIZE	RECOMMENDED CLAMP BOLT TORQUE (FT-LBS)
4" - 10"	100
12"	130

4" - 12" SIZES

PIPE RESTRAINERS 1200G2C SPECIFICATIONS*

NOM. SIZE ¹	PVC/PVCO PIPE WITH DUCTILE IRON PIPE O.D. STYLE 1200G2C	A	B APPROX.	C MAX.	PVC FITTING BELL OD "D"		RESTRAINT BOLTS/RODS		CLAMPING BOLTS		APPROX WT. (LBS)
	O.D.				MIN	MAX	QTY	SIZE	QTY	SIZE	
4	4.80	1.44	9.32	8.00	5.44	5.61	2	3/4 x 9	4	5/8 x 3-1/2	13.58
6	6.90	1.50	11.26	8.00	7.84	8.03	2	3/4 x 9	4	5/8 x 3-1/2	16.84
8	9.05	2.00	14.76	11.00	10.29	10.55	2	3/4 x 12	4	3/4 x 4	28.28
10	11.10	2.38	17.26	11.00	12.63	12.96	4	3/4 x 12	4	7/8 x 5	43.10
12	13.20	2.38	20.00	11.00	15.07	15.46	4	3/4 x 12	4	7/8 x 5	54.38

* All dimensions in inches except where indicated.

NOM. SIZE (IN)	C900			C909
	DR14+	DR18	DR25	PC 235
4	235	235	165	235
6	235	235	165	235
8	235	235	165	235
10	235	235	165	235
12	235	235	165	235

+ Derated due to rating of PVC pressure fitting.

STAR® PIPE PRODUCTS



Pipe Restrainers series 1200G2

1200G2C Restrainers for C900/C909 PVC/PVCO Pipe and PVC Pressure Fittings w/Ductile Iron Pipe OD (Formerly Series 9200)

INSTALLATION INSTRUCTIONS (SERIES 1200G2 4"-12")



STEP 1

Insert the pipe into fitting bell per fitting manufacturer's instructions.

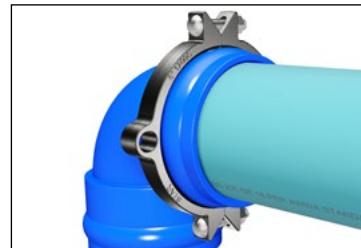

STEP 2

Assemble harness behind the bell of fitting using clamping bolts and nuts supplied. Evenly tighten to recommended torque.

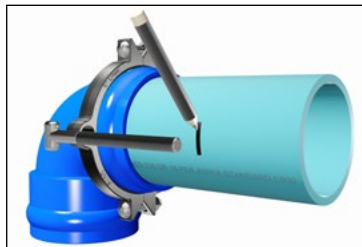

STEP 3

Using one of the T-bolts / rods (provided) mark a reference line such that the T-bolt / rod end extends past the nut by approximately 1/2".

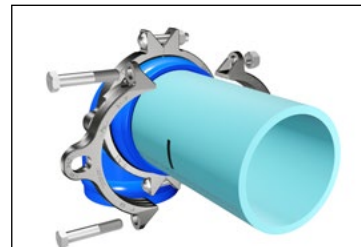

STEP 4

Make sure the open end of the restrainer ears are toward the joint. Tighten serrated restrainer clamp bolts evenly to recommended torque making sure the gap between bolt pads on both sides remain even.

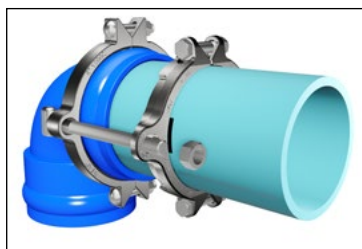

STEP 5

Insert the T-bolts / rods (provided) through restrainers as shown. For size 8" to 12", place a washer (provided) on each end of rod behind the restrainer ears. Snug tighten the nuts so that the spigot end is secured into the bell end.

Caution: Do not over-tighten restraining nuts. Turn nut to hand fight plus half turn.

RECOMMENDED CLAMP BOLT TORQUE	
PIPE SIZE (IN)	C900/C909 (FT-LBS)
4-10	100
12	130

STAR® PIPE PRODUCTS

